

**Q. How do you install a picture light?**

A. All House of Troy picture lights come with mounting hardware and may be attached to either the picture frame or the wall. The only tools necessary are a screw driver and something to start a screw-hole, such as a small nail or awl.

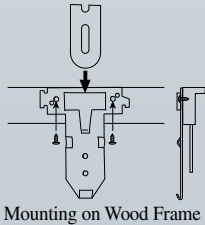

Mounting on Wood Frame

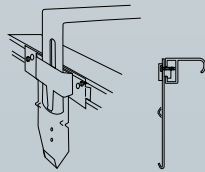

Mounting on Metal Frame

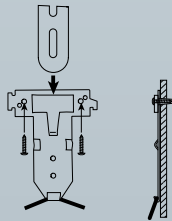

Mounting on Wall

**Q. In what order are shade dimensions given in this catalog?**

A. See drawing below.

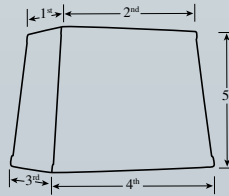
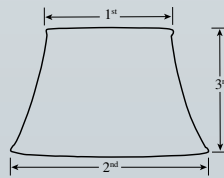

**Q. How do you measure a Desk/Piano Lamp?**

A. Adjustable Desk/Piano lamps are measured in the locations shown in the drawing below.

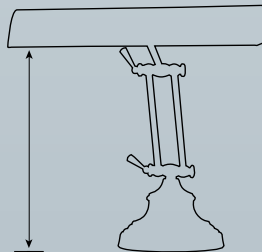

**Q. How is the arm extension measured on Swing Arm Lamps?**

A. On Wall Swings, the measurement is from the front of the backplate to the center of the socket. On Desk Lamps, the measurement is from the front of the post to the center of the socket.

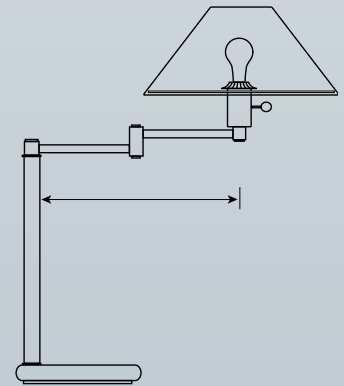

**Q. How can we display these products in our store?**

A. Call our Customer Service department for Picture Light display options.



**Picture Light Finishes**

Our Classic and Slim-line™ picture lights are offered in the most popular finishes. If you would like a finish that is not stocked, call our customer service department for lead time and cost.

The antique and weathered brass finishes are applied then rubbed by hand to achieve the proper effect. For this reason there are slight surface variations which are expected and desirable.

The stocked finishes are listed on the product page. Refer to this page for a color representation of finish.



Gold #1

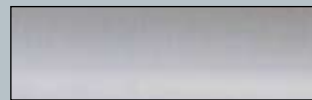

Brushed Aluminum #32

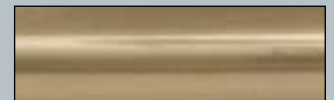

Antique Brass #71



Gold Wrinkle #2



Satin Brass #51

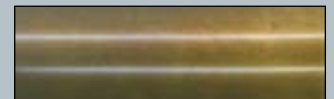

Weathered Brass #76



Bronze #5



Satin Nickel #52



Mahogany Bronze #81



Black #7

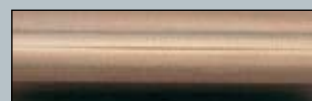

Statuary Bronze #56

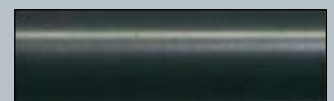

Oil Rubbed Bronze #91



White #9

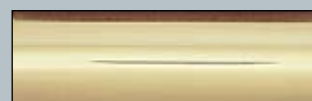

Polished Brass #61



Chestnut Bronze (CHB)

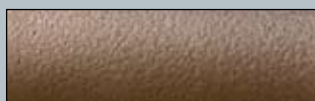

Hammered Bronze (HB)

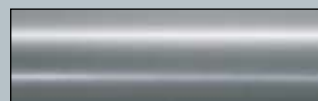

Pewter #31



Chrome #62



Granite (GT)